

High Performance BGA Cooling Solutions w/ maxiGRIP™ Attachment*

DIGI-KEY PART # **ATS1150-ND**

ATS PART # ATS-53230D-C2-R0

Features & Benefits

High aspect ratio, straight fin heat sinks that are ideal for compact PCB environments

maxiGRIP™ attachment applies steady, even pressure to the component and does not require holes in the PCB

Designed specifically for BGAs and other surface mount packages

Meets Telcordia GR-63-Core Office Vibration; ETSI 300 019 Transportation Vibration; and MIL-STD-810 Shock Testing and Unpackaged Drop Testing standards

Comes preassembled with high performance, phase changing, thermal interface material

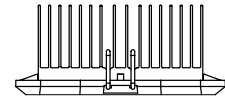
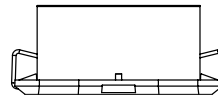
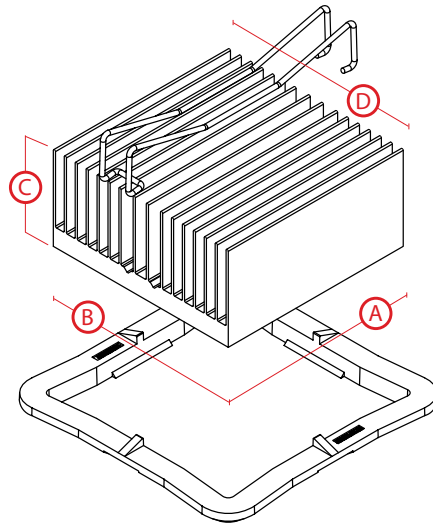

Thermal Performance Table

AIR VELOCITY		THERMAL RESISTANCE	
FT/MIN	M/S	°C/W (UNDUCTED)	°C/W (DUCTED)
200	1.0	16.8	7.6
300	1.5	12.4	
400	2.0	10.5	
500	2.5	9.3	
600	3.0	8.5	
700	3.5	7.8	
800	4.0	7.3	

Product Details†

DIMENSION A	DIMENSION B	DIMENSION C§	DIMENSION D	TIM†	FINISH
23	23	9.5	N/A	C1100F	BLACK-ANODIZED

For further technical information, please contact Advanced Thermal Solutions, Inc. at **1-781-769-2800** or www.qats.com

* RoHS Compliant

‡ TIM = Thermal Interface Material

† Dimensions are measured in millimeters

◆ Dimensions A & B refer to component size

§ Dimension C = the height of the heat sink shown above and does not include the height of the attachment method



ATS ADVANCED THERMAL SOLUTIONS, INC.

Innovations in Thermal Management®



To place an order, please visit www.digikey.com